



EAR FORCE[®]

XBOX LIVE[®] Chat plus
Wireless Digital RF Game Audio with
Dolby[®] Headphone 7.1 Surround Sound

X41

User's Guide



For more products, accessories and our product support knowledge base, please visit

TurtleBeach.com

For warranty information, please visit <http://support.turtlebeach.com>

System Requirements

XBOX 360[®] game console with one of the following cables to support digital output:

- XBOX 360 Component HD AV cable
- VGA HD AV cable
- S-Video AV cable
- Advanced SCART AV cable

XBOX LIVE requires a subscription.

Package Contents

- X41 wireless headset
- Removable boom microphone
- X41 wireless transmitter
- DC power cable
- Digital Optical cable
- (2) AAA batteries
- XBOX talkback cable
- This User's Guide

FCC Caution:

Any Changes or modifications not expressly approved by the party responsible for compliance could void the user's authority to operate the equipment. This device complies with part 15 of the FCC Rules. Operation is subject to the following two conditions: (1) This device may not cause harmful interference, and (2) this device must accept any interference received, including interference that may cause undesired operation.

This product is CE marked according to the provisions of the R&TTE Directive (99/5/EC)

Frequency Range: 2.404-2.476GHz

Grantee Code/Reg Number: XGB/GC229855

FCC Code: XGB-TB2170, XGB-TB2171

Voyetra Turtle Beach, Inc.



Copyright © 2009 Voyetra Turtle Beach, Inc. (VTB, Inc.) All Rights Reserved. No part of this document may be reproduced without permission. Turtle Beach, the Turtle Beach logo, Voyetra, Ear Force, the Digital RF logo, and Chat Boost are either trademarks or registered trademarks of VTB, Inc. XBOX, XBOX 360 and XBOX LIVE are registered trademarks of Microsoft Corporation. Dolby, Pro Logic, and the double-D symbol are registered trademarks of Dolby Laboratories. All other Trademarks are properties of their respective owners and are hereby acknowledged. Product Features, visual design, prices, package contents and specifications are subject to change without notice. Manufactured under license from Dolby Laboratories. P/N TBS-2170-01 V1

Safety Notice

To avoid potential damage while transporting the device, always disconnect the talkback cable from the XBOX controller and headset.

WARNING: Permanent hearing damage may occur if a headset is used at high volumes for extended periods of time, so it is important to keep the volume at a safe level. Over time, your ears adapt to loud volume levels, so a level that may not cause initial discomfort may still damage your hearing. If you experience ringing in your ears after listening with the headset, it means the volume is set too loud. The louder the volume is set, the less time it takes to affect your hearing. So, please take care to listen at moderate levels.

- Be careful when turning on the headset. Before placing the headset on your ears, turn down the volume, then slowly increase it to a comfortable level.
- Turn down the volume if you can't hear people speaking near you.
- Avoid turning up the volume to block out noisy surroundings.

Technical Specifications

X41 Transmitter

- Digital Wireless RF carrier transmission (2.404-2.476GHz)
- RF transmission range approximately 30 feet
- Wired stereo headphone amplifier 35mW per channel
- Frequency response: 20Hz - 20kHz
- Optical TOSLINK digital audio input compatible with 48kHz digital audio stream
- Optical TOSLINK digital audio output pass-through of digital input stream
- 150MIPS Digital Signal Processor for Dolby processing
- Maximum analog input level with volume control on maximum setting: 2Vpp (700mV rms)
Input sensitivity may be adjusted to accept higher level signals by lowering the volume control
- Weight: 8.4 Oz (240g)
- Power requirements: 5VDC @180mA

X41 Headset

- 50mm diameter speakers
- Digital Wireless RF carrier reception (2.404-2.476GHz)
- Speaker Frequency Response: 20Hz - 20kHz , >120dB SPL @ 1kHz
- Condenser Microphone Frequency Response: 50Hz - 15kHz
- Headphone Amplifier: Stereo 35mW/ch, THD <1%
- Bass Boost: +9dB @20Hz - 150Hz
- Chat Boost Talkback Expander: +10dB gain boost at maximum game volume
- Operates on dual AAA batteries
- Automatic battery power shut down after approx 5 minutes of carrier loss or silence detection
- Battery life: Up to 25 hours of continuous use with alkaline cells
- Weight: 9.5 Oz (270g)

X41 Headset and Talkback Cable

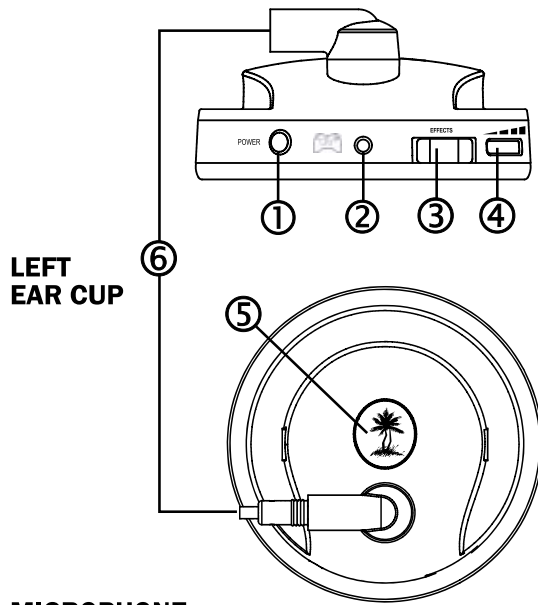

LEFT EAR CUP

MICROPHONE



Remove the foam cover and insert the mic boom so the holes in the mic casing are facing your mouth. Then replace the foam cover.

Markers on the jack indicate the proper position when the foam cover is on the mic

RIGHT EAR CUP

Insert both AAA batteries with the positive side facing down

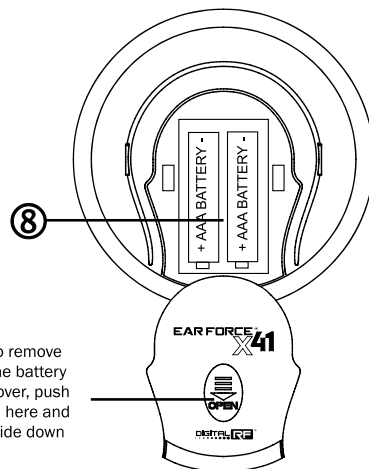

To remove the battery cover, push in here and slide down

XBOX TALKBACK CABLE

Insert the straight plug into the headset XBOX jack (2) and the right angle plug into the XBOX controller

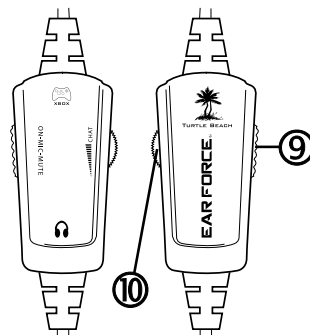

① Power Switch: Turn on the headset by pressing the power switch (1) for a couple of seconds, then release. The power LED (5) should start flashing. Turn off by pressing the button (1) until the LED (5) stays on, then release.

② XBOX Controller Jack: Insert the straight connector on the talkback cable (see below) here.

③ Effects Button: Press this button to activate the bass boost effect. A high pitched beep indicates that bass boost is on. Press again and a low pitched beep indicates that it's turned off.

④ Game Volume: Turn to adjust the game sound level. The XBOX LIVE chat volume may be independently set by the volume control on the talkback cable.

⑤ Power LED: Flashes about once per second when power is on. To conserve batteries, the headset will turn off after several minutes if there's no sound or if the transmitter is turned off. In this case, the LED on the left ear cup will flash faster to indicate that it will soon shut off.

⑥ Microphone socket: Insert the removable mic boom here. The socket is notched to prevent the boom from rotating after insertion.

⑦ To properly position the mic, remove the foam cover, insert the boom into the socket (6) so the holes on the mic casing (7) are facing your mouth. Then replace the foam cover. The boom jack also has a marker to indicate the proper mic position.

⑧ Installing Batteries: The headset is powered by 2 AAA batteries located in the right ear cup. Push in and pull down on the lid to remove. Insert both batteries with the positive sides facing down.

⑨ Mic Mute Switch: Use the mic mute switch to turn off the mic when you don't want to be heard.

⑩ Chat Volume Control: Use this volume control to adjust the incoming chat level in the headset.

X41 Transmitter

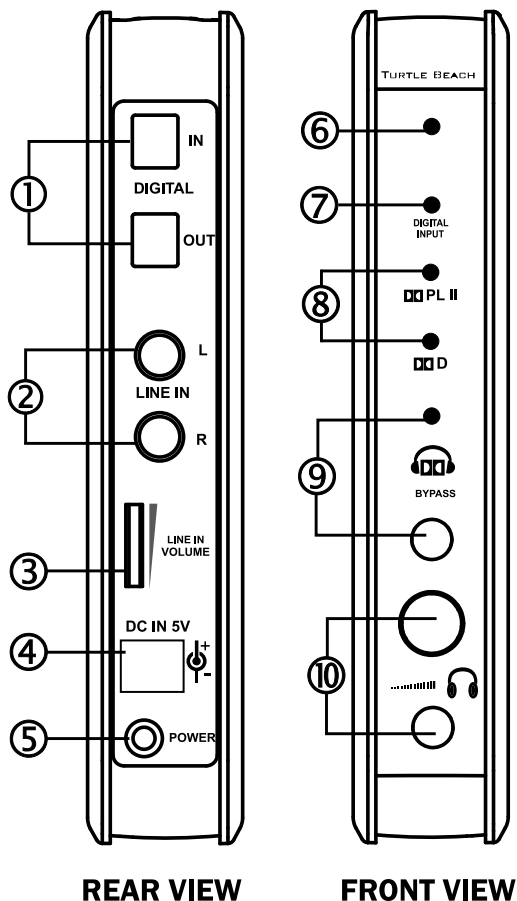

① **Digital Input and Output:** Connect the digital input (top) to the XBOX 360 digital output using the included digital optical cable. The digital input (top) is passed through to the digital output (bottom) so you can connect the X41 transmitter and your home theater system to hear the XBOX® on the headset and speakers at the same time. **When the XBOX digital signal is active, the analog inputs (2) are disabled.**

② **Line In (stereo analog inputs):** Use these inputs to connect analog audio sources, such as a TV, MP3 Player, etc. If the Bypass (9) is turned off, the analog stereo signal will be processed by the Dolby Pro Logic IIx decoder, producing an expanded stereo effect.

③ **Line In Volume:** Sets the sensitivity of the analog inputs to accept a wide range of input levels. **This control has no effect on the digital input signal level.** Typically, this should be set to maximum and the headset volume used to adjust the listening level. If the sound distorts, turn down the Line In volume (3) to prevent overloading the analog inputs.

④ **Power Socket:** Insert the included X41 power cable into this socket. Insert the other side of the cable into a free USB port on the XBOX console or nearby PC or laptop.

⑤ **Power Switch:** Push to turn on the transmitter power.

⑥ **Power/Link Indicator LED:** When the transmitter is powered on and communicating with the headset, this LED will be on solid. If this LED is slowly pulsing, it means the transmitter can't communicate with the headset. This could happen when the headset is turned off or out of range.

⑦ **Digital Input Indicator LED:** This LED turns on when a digital input signal is detected. When this LED is on, the analog inputs are turned off.

⑧ **Dolby Processing Indicator LEDs:** The **PL II** LED will light whenever the digital or analog input is being processed by the Dolby Pro Logic IIx decoder. The **D** LED will light whenever the digital input signal is being processed by the Dolby Digital surround sound decoder. Both LEDs will turn off when the Bypass is ON.

⑨ **Bypass Button and Indicator LED:** Pressing this button turns off the Dolby processing, allowing you to hear the unmodified input signal in stereo. The LED will turn on when Bypass is active and Dolby Processing is disabled.

⑩ **Wired Headphone Volume Control and Output Jack:** Insert a pair of optional wired headphones into this jack to hear the same signal as the wireless headset. This may be used as a second set of headphones so two people can hear the game. The volume control does not affect the wireless headset.

Using the Transmitter

Transmitter Range

The transmitter and headset communicate via radio frequency (RF), so a direct line of sight is not required. The operating range is approximately 30 feet. When you're out of range, you may hear popping or clicking sounds if the headset loses the RF signal. For best performance, place the transmitter in an open area that is unobstructed by objects that might absorb RF signals from the internal antenna. Avoid placing it on a metal surface, such as the top of a home theater A/V receiver.

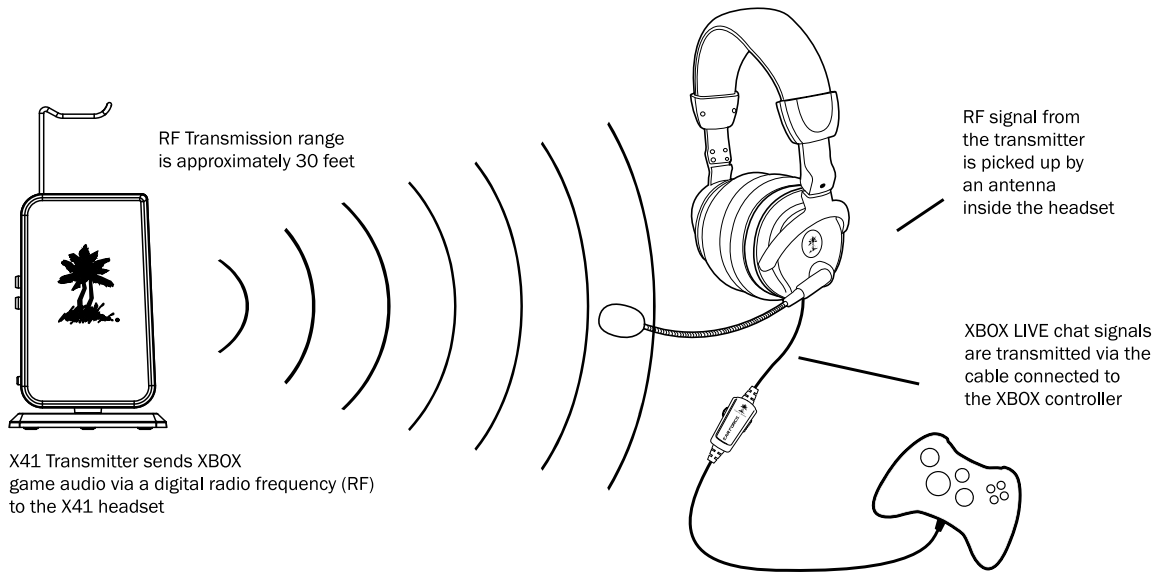

When the transmitter and headset are communicating, the top LED on the front of the transmitter will be on. If this LED is slowly pulsing, it means the transmitter can't communicate with the headset. This could happen if the headset is turned off, out of range or needs to be "paired".

Using Wired Headphones

The transmitter can only communicate with one wireless headset, so two wireless headsets cannot be used with the same transmitter. The headphone jack on the front of the transmitter can be used to connect a set of wired headphones for listening to the game sound being transmitted to the wireless headset. The volume control above the jack sets the volume of the wired headset and does not affect the volume of the wireless headset.

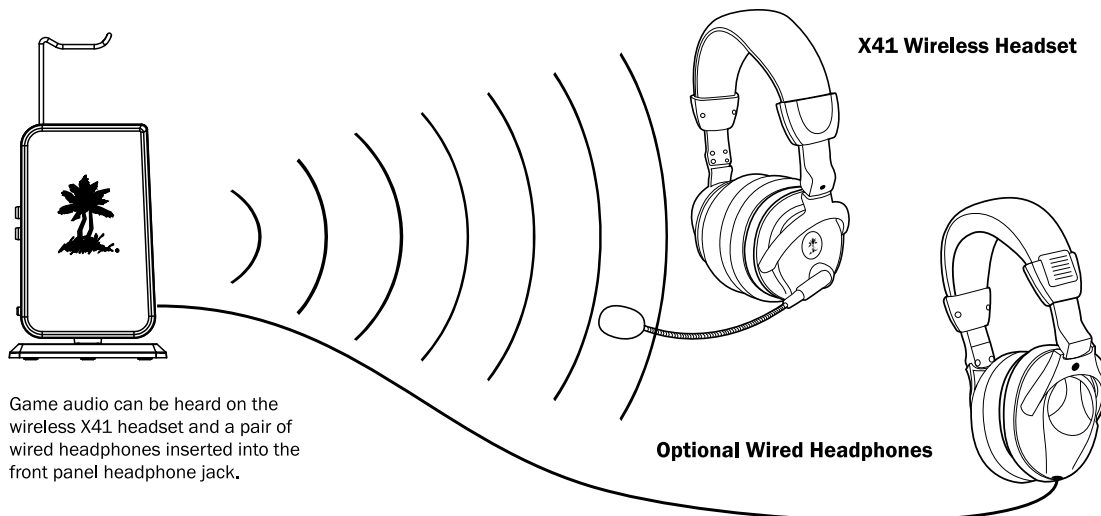

Setting up the XBOX 360® and Ear Force® X41

STEP 1: Connect the XBOX® to the X41 Transmitter

1. Connect the XBOX 360 AV cable to your XBOX as described in the XBOX User's Guide.
2. Connect the X41 TOSLINK digital optical cable (included) from the digital output on the XBOX AV cable (1) to the digital input on the transmitter (2).

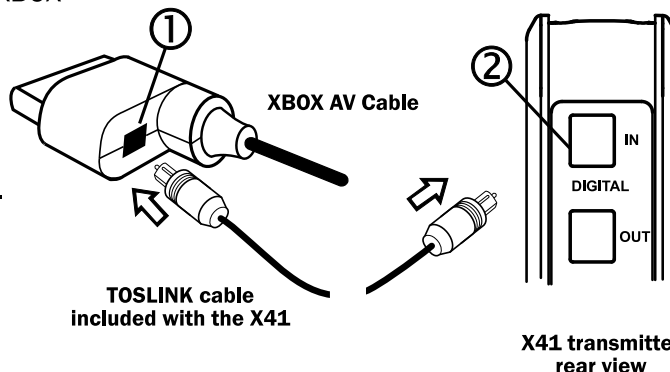

Note: Remove the protective caps from each end of the optical cable before inserting it into the sockets.

Step 2: Connect the power

1. Connect the X41 DC power cable to the X41 power socket (3). Plug the other side into a free USB port on the XBOX.
2. Press the power switch (4). Check if the X41 front panel LEDs turn on.

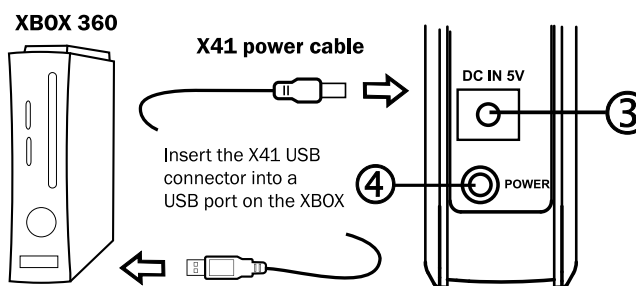

Step 3: Insert the headset batteries

1. Remove the battery cover in the right ear cup by pushing in and down.
2. Insert the two included AAA batteries with the positive side facing down.
3. Replace the battery cover.

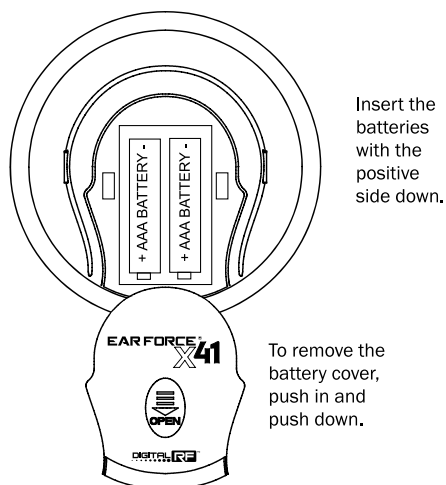

Step 4: Insert the mic boom

1. Insert the mic boom into the jack (5) so that the holes in the mic casing are facing your mouth.
2. Place the foam cover over the mic if desired.

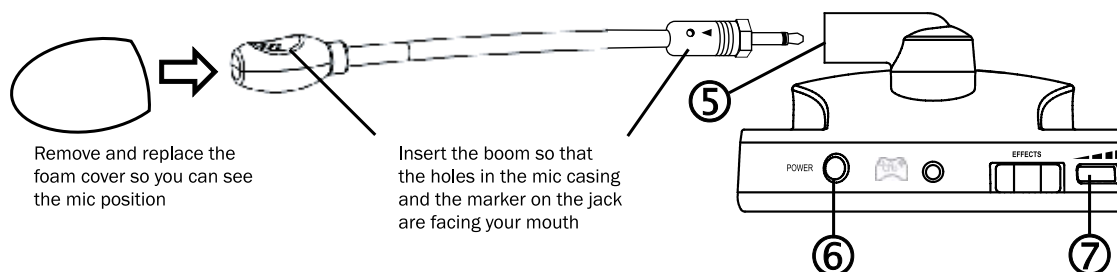

Continued >>>

Continued >>>

Step 5: Turn on the headset power

1. Press and hold the power switch **(6)** for a couple of seconds, then release. The Turtle Beach logo on the left ear cup should start flashing. If it doesn't, make sure the batteries are inserted properly. If they are, then try a different set of batteries.
2. Turn up the volume control **(7)** and listen for sound from your XBOX. The top LED on the front of the transmitter should be on solid when the headset and transmitter are communicating. If there's no sound, check the **"Troubleshooting Tips"**.

STEP 6: Configure the XBOX audio settings

1. In the **System Settings** section of the XBOX Dashboard, select **Console Settings**, then select **Audio**.
2. In the **Audio Settings** area, select **Digital Output** then **Dolby Digital 5.1** to activate the Dolby Digital output.
3. Start your game.

To turn off the power, press and hold the power switch until the LED turns on. Once it's on, release the button and the power will turn off.

Automatic Power Shut-off

To conserve batteries, the headset will turn off after several minutes if there's no sound or if the transmitter is turned off. In this case, the LED on the left ear cup will flash faster to indicate that it will soon shut off.

Using an HDMI connection for video

If your TV only uses an HDMI AV connection, you must still use an XBOX 360 AV cable to connect your X41 audio to the XBOX. This cable set is included with the XBOX Elite model. If you do not have an XBOX Elite, the optional Elite AV cable is compatible with any other XBOX model. It is available to purchase from the official XBOX website:
<http://www.xbox.com/en-us/hardware/x/xbox360hdmiavcable/>

Pairing the X41 Headset and Transmitter

The headset and transmitter in this package are "paired", which means they're synchronized to ensure they work together. When the headset and transmitter are communicating, the top LED on the front panel of the transmitter will be on solid. If this LED is instead slowly pulsing, it means the transmitter can't communicate with the headset. This could happen if the headset is turned off or out of range. If the LED is slowly pulsing when the headset is on and within range, then they might need to be "paired" as described below:

Step 1:
Make sure the headset is off by pressing the "Power" button until the LED turns on, and then release it. Make sure the headset LED is off.

Step 2:
Then press and hold the headset power button until the LED turns on solid and release the button when the LED turns off. The headset LED will start to flash rapidly.

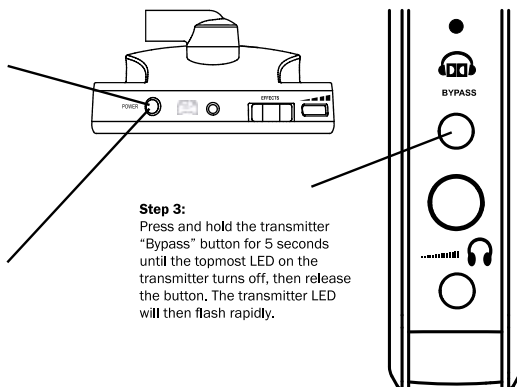

After a few seconds, the topmost transmitter LED should be on solid and the headset LED should be flashing about once per second, indicating that the units are paired.

Interference from Two Headsets

Only one headset can be paired with the transmitter. If you pair two headsets with the same transmitter, they'll interfere with each other as they compete for the transmitter RF signal. This will cause one headset to shut off. So don't try to pair two headsets with the same transmitter!

Using XBOX LIVE® Chat

XBOX LIVE is a subscription feature offered with the XBOX 360 that lets you communicate with other players via the Internet. The X41 can be used to communicate with other players during XBOX LIVE multi-player gaming sessions. To use this feature, configure the XBOX LIVE feature and connect the headset to the XBOX 360 controller as described below.

Connecting the talkback cable

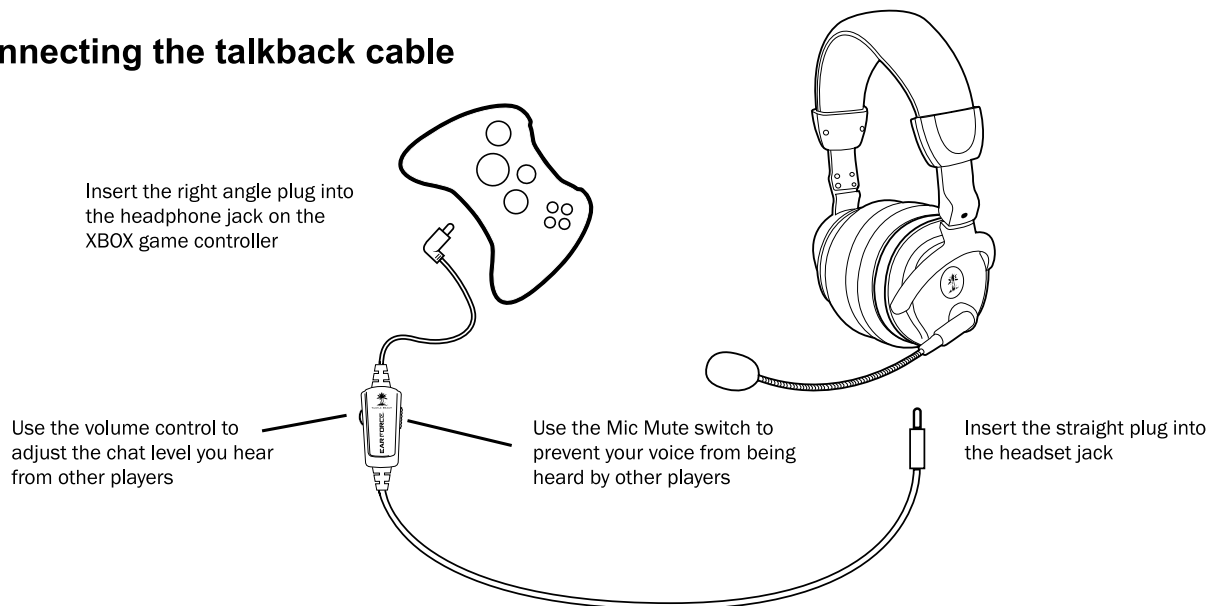

Mic Mute Switch: The mute switch on the talkback cable can be used to silence the headset mic when you don't want to be heard during XBOX LIVE sessions.

Chat Volume: The volume control on the talkback cable can be used to adjust the chat volume of online players heard in your headset. The Chat Boost feature automatically increases the chat level as the game volume increases, as explained in the "Chat Boost" section.

Adjusting the Microphone Position: For optimum clarity, adjust the microphone so that it is situated a few inches away from your mouth and the microphone's active area is facing your mouth. If you're not sure about the mic position, remove the foam mic cover, turn the holes in the mic housing towards your mouth and then replace the foam cover. Or, check the triangle marker on the boom jack, which is aligned with the mic holes and also should be facing your mouth.

Microphone Monitoring Feature:

When the talkback cable is inserted into the headset's XBOX jack, the mic monitor feature mixes a portion of the microphone signal into the headset signal so you can hear your voice along with game audio and incoming chat from teammates or other gamers.

Continued >>>

Continued >>>

Configuring the XBOX LIVE settings

The X41 headset lets you communicate with other players during XBOX LIVE multi-player online gaming sessions. To use this feature, connect the headset to the XBOX controller as described in the previous section, then configure the XBOX LIVE Voice settings as described below.

1. Press the center XBOX button on your controller to bring up the Dashboard.
2. Navigate right to the Settings tab and scroll down to "Preferences" from the menu. Press the "A" button.
3. On the Preferences screen, select the "Voice" option and Press "A".
4. Select the "Play Through Headset" option and set the Volume to 10.



Balancing Game and Chat Levels

The headset volume sets the game sound level. The volume control on the talkback cable adjusts the level of incoming chat from other players on XBOX LIVE. Adjusting these two volume controls lets you balance the game sound and chat voices during an XBOX LIVE session.

Using the Chat Boost™ feature

Chat Boost is a dynamic talkback expander built into the X41 headset that automatically increases XBOX LIVE chat during loud moments in your game, so you can always hear your teammates or other players, regardless of the game volume.

Typically, if you turn up a headset's game volume, the incoming chat level from other players could become difficult to hear over the game sound. However, with Chat Boost, as the game audio increases, the chat volume also increases. This allows the incoming chat to keep up with the game volume level, so you can always hear what other players are saying. When the game volume quiets down again, Chat Boost automatically returns the chat level to your original volume setting.

To properly set the Chat Boost function:

1. Turn down the volume control on the headset so there's no game audio.
2. Adjust the volume control on the talkback cable so you can hear the chat voices at a comfortable level.
3. Turn up the headset game volume and the chat volume will increase whenever the game gets louder, just as if the talkback volume control is being automatically turned up along with the game level. Note that if the volume on the talkback cable is set too loud, Chat Boost might increase the volume so much that the voices will distort. If that happens, turn down the talkback volume on the talkback cable.

Volume Settings

The X41 has three volume control settings that interact in the following manner:

Transmitter Volume Control for analog inputs (located on the back of the transmitter)

This controls only the volume of the stereo analog inputs and has no effect on the transmitter digital input volume. That means, if the XBOX is connected to the transmitter's digital input, the game volume will not be affected by this volume control. This volume control is only used when the analog inputs are being used (for example if you've connected your TV set to the transmitter) and in most cases it would be set to maximum. If you're using the transmitter's analog inputs and hear distortion in the headset, the signal might be overloading the transmitter input. If that happens, turn down the transmitter volume control to reduce the analog input level until the distortion is corrected.

Headset Game Volume Control (located on the headset)

This sets the volume of the game sound transmitted to the headset. It has no effect on the XBOX LIVE chat volume, which is set independently as described below. If you're listening to an analog signal connected to the X41 transmitter (for example, if you've connected your TV to the transmitter), set the transmitter analog volume control as loud as possible for distortion-free sound and adjust the headset volume to a comfortable level.

XBOX LIVE Chat Volume Control (located on the XBOX talkback cable)

This controls the chat level heard in the headset during an XBOX LIVE gaming session. Set the chat level with this control and adjust the game sound level with the volume control on the headset. The volume control on the headset has no effect on the chat volume level, so even if you turn the game volume control all the way down, you'll still hear the chat signal if the chat volume control is turned up.

Connecting your Home Theater Speakers and TV

Setting up the transmitter as illustrated below lets you listen to your XBOX or TV with the X41 headset. You can also hear the XBOX on your home theater speakers without disconnecting the optical cable from the transmitter.

The transmitter's analog inputs connected to the TV will automatically shut off whenever the XBOX is active, as indicated by the digital input LED on the transmitter front panel. When the XBOX is turned off, the transmitter analog inputs will automatically turn on so you can listen to TV shows with the X41 headset without having to disconnect cables.

Connecting the X41 transmitter digital output to your home theater system will pass the XBOX game audio from the transmitter's digital input to the home theater AV receiver digital input, so you can hear the game on the headset and your surround sound speakers at the same time. To hear the game only on the X41 headset, turn down or mute your speakers.

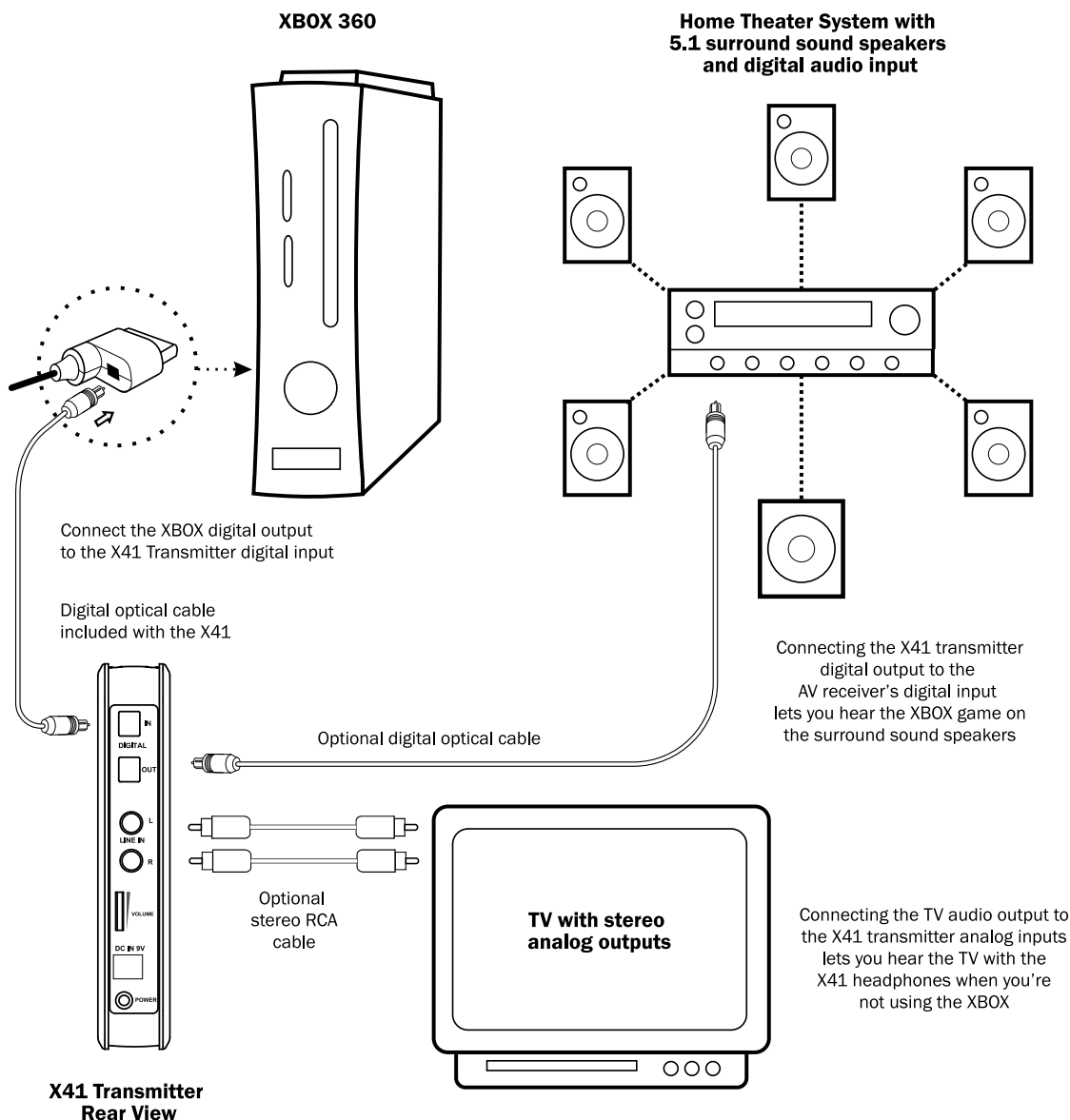

Transmitter Input Modes and Dolby Processing

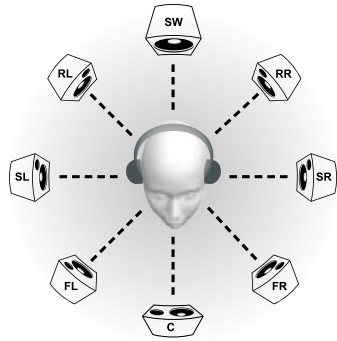

**Sound field with Dolby® Headphone 7.1
Surround Sound processing**



Stereo sound field

The X41 uses Dolby Pro Logic® IIx, Dolby Digital, and Dolby Headphone surround processing technologies, the industry-standard formats for encoding multi-channel game audio. Dolby Headphone processing recreates 7.1 channel surround sound using the X41 stereo headset so you can hear the sound all around you, as if you were listening to a 7.1 speaker system.

The transmitter supports three types of digital source material and analog stereo. When the Bypass button is ON, Dolby processing is defeated, so you can hear the unprocessed input signal in stereo, as it sounds from the source. Here's how the signal processing modes operate:

- When the digital input signal is active, the front panel digital LED turns on and the analog inputs are turned off. You do not have to disconnect cables to switch between analog and digital sound sources.
- If the Bypass LED is on, Dolby processing is defeated and the signal will be heard as stereo.
- If the digital input is a Dolby Digital 5.1 or 7.1 channel signal, the front panel **DD D** LED turns on and Dolby Headphone processes the channels to create surround sound in the headset.
- If the digital source is a Dolby Pro Logic IIx signal, both Dolby LEDs will turn on and Dolby Headphone creates Pro Logic IIx surround sound in the headset.
- If the digital input is stereo, the **DDPL IIx** LED turns on and the signal is processed by Dolby Headphone to create an expanded stereo sound in the headset.
- If the digital input is not active (or is disconnected) the analog stereo signal will be active.
- If there is an analog stereo input and the Bypass LED is on, there will be no Dolby processing and the signal will be heard as stereo.
- If there is an analog stereo input and the Bypass LED is off, the front panel **DDPL IIx** LED turns on and the analog stereo signal is processed by Dolby Pro Logic IIx and Dolby Headphone to create an expanded stereo sound in the headset.

Troubleshooting Tips

No sound

- Check that the transmitter and headset volume controls are both turned up.
- Check that the transmitter power and optical cables are properly connected.
- Check that the headset is powered on. The LED on the left ear cup should be flashing.
- Check if the top LED on the front of the transmitter is on solid. If the LED is slowly pulsing, it indicates that the transmitter isn't communicating with the headset. If the headset is on solid and the transmitter LED is slowly pulsing, then the headset and transmitter need to be "paired" as described in the section "**Pairing the X41 Headset and Transmitter**".

Audio Drops, Popping or Clicking Sounds

Audio dropouts, popping or clicking sounds on the headset are caused by poor reception. This can occur when:

- The headset and transmitter are out of range. For best performance, stand within 20 feet from the transmitter.
- There's a wall or other large object between the headset and transmitter.
- The transmitter is in a bad location that is interfering with the antenna.
- A wireless base station or wireless LAN are causing a lot of RF activity that's blocking the RF signal from the transmitter.

Low Battery Symptoms

When battery power is low, the headset power might shut down soon after you turn it on, or it might turn off during very loud sounds in the game. If this happens, replace the batteries with fresh alkaline batteries or with fully charged NiCad batteries.

Sound Too Low when using the Analog Inputs

If you're listening to the analog inputs on the transmitter and the sound is too low, even with the headset volume turned up all the way, turn up the volume on the transmitter or on the audio source. Note that the transmitter volume control has no effect on the digital input.

Audio Distortion when using the Analog Inputs

If the sound is distorted when using the transmitter analog input, it may be that the audio source is overloading the transmitter. Try turning down the volume on the transmitter to reduce the input sensitivity, then turn up the headset volume to a comfortable level. Note that the transmitter volume control has no effect on the digital input.

Analog Input isn't working

The transmitter analog inputs will automatically shut off whenever the digital input is active. To hear the analog input signal, either disconnect the optical cable from the digital input on the transmitter, or shut off the device connected to the optical cable (e.g. XBOX) to disable the digital audio signal.

Properly Positioning the Headset

Don't wear the headset with the headband behind your head. The headband must be positioned on top of your head to optimize the surround sound effect.

